

Tubular motor:

GEIGER-SOLIDline
GEIGER-SOLIDline ../55

Motor control:

GEIGER-Easy-ZIP 1.x, 2.x and 3.x (GU45.. E10)

for screens with ZIP guidance

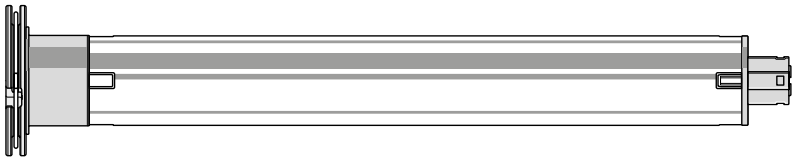

EN

**Original assembly and
operating instructions**

EN

Index

1. General information	2
2. Guarantee	2
3. Intended use	3
4. Safety instructions	3
5. Safety instructions for assembly	4
6. Installation instructions	5
7. Information for the specialist electrician	6
8. Connection of the setting switch	6
9. Control options	7
10. Setting of the end positions with Easy-ZIP 1.x	7
11. Setting of the end positions with Easy-ZIP 2.x (Qi mode)	11
12. Setting of the end positions with Easy-ZIP 3.x (automatic mode)	11
13. Obstacle detection	12
14. Deactivating the obstacle detection in DOWN direction	13
15. Reactivating the obstacle detection	13
16. End position correction	13
17. What to do if	13
18. Maintenance	13
19. Declaration of conformity	14
20. Technical data for SOLIDline motors with 16 revolutions per minute	15
21. Technical data for SOLIDline motors with 55 revolutions per minute	15
22. Notes on waste disposal	16

EN

1. General information

Dear customer,

By purchasing a Geiger motor you have decided on a quality product from Geiger.

Thank you very much for your decision and the confidence placed in us.

Before you put this drive into operation please observe the following safety instructions. It serves for the prevention of danger and for the avoidance of personal injury and damage to property.

The installation and operating instructions contain important information for the installer, the specialist electrician and the user. Please pass on these instructions if you transfer the product. These instructions should be kept by the user.

2. Guarantee

In the case of incorrect installation contrary to the installation and operating instructions and/or constructional modification, the legal and contractual guarantee for property damage and product liability lapses.

3. Intended use

The motors of the series **SOLIDline (GU45.. E10)** with electronic end stop are designed exclusively for the operation of ZIP screens.

The motors may not be used for the operation of roller grilles, garage doors, furniture and lifting tools.

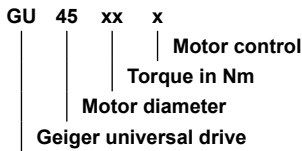

4. Safety instructions



ATTENTION: Important safety instructions. For personal safety, it is important to follow these instructions. Please keep these instructions for future reference.

- ▶ Do not allow children to play with stationary controls. Keep remote controls away from children.
- ▶ The installation is to be checked regularly for defective balance, signs of wear or damaged cables and springs, if relevant.
- ▶ Do observe the moving sun protection system and keep persons away until it has closed completely.
- ▶ When operating the manual release with the sun protection system open, please be cautious as it can fall down quickly if springs or tapes wear off or are broken.
- ▶ Do not operate the device if operations such as, for example, window cleaning are to be carried out in the vicinity.
- ▶ Disconnect the automatic controlled device from the mains power supply if operations such as, for example, window cleaning are being carried out in the vicinity.
- ▶ During operation observe the danger zone.
- ▶ Do not use the installation if people or objects are in the danger zone.
- ▶ Urgently shut down damaged installations until repair.
- ▶ Unconditionally shut down the unit during maintenance and cleaning operations.
- ▶ Pinching and shearing points are to be avoided and must be secured.
- ▶ This appliance can be used by children aged 8 and above and persons whose physical, sensorial or mental capacities are impaired, or who have no experience or know-how if they have been supervised or been given instructions on the use of the appliance and if they understand the possible resulting dangers. Children are not permitted to play with the device. Cleaning and maintenance should not be carried out by children.
- ▶ The rated sound pressure level is less than 70 dB(A).
- ▶ Disconnect the device from the mains power supply for maintenance and replacement of parts.
If the motor is disconnected via a plug connection the operator must be able to control - from any place to which it has access – that the plug is removed.
If this is not possible - due to design or installation - the disconnection from the power supply must be ensured via locking in the disconnected position (e.g. isolator).
- ▶ The motor tube can get very hot during prolonged use.
When working on the unit, do not touch the tube before it has cooled down.

EN

5. Safety instructions for assembly



ATTENTION: Important safety instructions. Follow all installation instructions, as incorrect installation can lead to serious injuries.

- ▶ When mounting the motor without any mechanical protection of the driven parts and of the tube which may become hot, the motor must be installed at a height of at least 2.5 m above the ground or of another level which provides access to the drive.
- ▶ Before the motor is installed, all cables which are not needed are to be removed and all equipment which is not needed for power-operated actuation is to be put out of operation.
- ▶ The actuating element of a manual release must be mounted at a height of less than 1.8 m.
- ▶ If the motor is controlled by a switch or pushbutton, the switch or pushbutton must be mounted within eyeshot of the motor. The switch or pushbutton must not be located in the vicinity of moving parts. The height of installation must be at least 1.5 m above the floor.
- ▶ Permanently installed control devices must be attached visibly.
- ▶ In case of devices extending horizontally, a horizontal distance of at least 0.4 m must be respected between the fully extended part and any other fixed element.
- ▶ The rated speed and the rated torque of the motor must be compatible with the device.
- ▶ The mounting accessories that are used must be designed in accordance with the selected rated torque.
- ▶ Good technical knowledge and good mechanical skills are necessary for the motor installation. Incorrect installation can lead to serious injury. Electrical work must be carried out by a qualified electrician in accordance with the regulations in force locally.
- ▶ Only use connecting cables that are suitable with the environmental conditions and which meet the construction requirements. (see accessories catalogue)
- ▶ If the device is not equipped with a connecting cable and a plug, or other means for disconnecting from the mains with a contact opening on each pole according to the conditions of the overvoltage category III for full disconnection, a disconnecting device of this type must be incorporated into the permanently installed electrical installation according to the wiring rules.
- ▶ Do not mount the connecting cables near hot surfaces.
- ▶ A plug for the disconnection of the motor from the power supply must be accessible after installation.
- ▶ Damaged connecting cables must be replaced by Geiger connecting cables of the same type.
- ▶ The device must be mounted as described in the installation instructions. Fixations shall not be made with adhesives since they are regarded as unreliable.

6. Installation instructions



Before fixing, the strength of the masonry or of the subsurface is to be checked.



Prior to installation please check to ensure there is no visible damage to the motor like cracks or open cables.



Caution: If the tube is screwed/riveted to the drive, the measure must be taken from the tube end to the center of the drive and marked on the tube.

When drilling the winding shaft **never** drill into the area of the tubular motor!

When inserting into the shaft, the tubular motor must **not** be struck and must **not** be allowed to fall into the shaft.

Installation into the screen:

Insert motor with a suitable adapter and drive into the shaft up to the stop of the shaft adapter.

Fix the motor support on the side piece.

Fix the motor together with the shaft on the motor support.

Depending on the selected motor head, different fixation systems can be used:

- Place the motor with square insert in the star-shaped bearer and lock with pin
- Place the motor into the existing engine bearer and lock
- Place the motor in a compatible engine bearer with clip system and lock with spring or rotating lever



The Geiger-SOLIDline motor is suitable for shaft diameters from 50 mm!

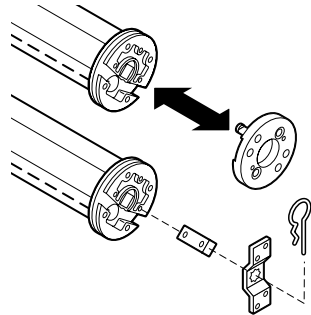
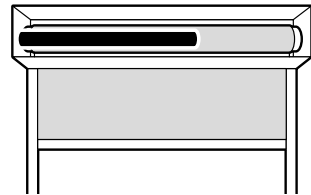
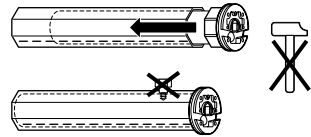

EN

7. Information for the specialist electrician



Caution: Important installation instructions. Please follow all instructions since incorrect installation can lead to the destruction of the motor and the switching unit.

The operations with the service clamps may be accomplished only by an electrical specialist.

Motors with electronic limit stops can be connected in parallel. In this case the maximum load of the switching unit must not be exceeded.

When changing the running direction the switchover must be effected through an off-position.

When changing the running direction the switchover time must be at least 0.5 s.

With a three-phase network, please use the same external conductor in order to control the UP and DOWN directions. PVC cables are not suitable for equipment used outdoors or exposed to prolonged high levels of UV radiation. These cables should not be used if they are likely to touch metal parts that can heat up to temperatures exceeding 70°C. Connecting cables with plug connectors of the Hirschmann Company are tested and approved with couplings of the Hirschmann Company.

In order to prevent a malfunction caused by coupling, the supply line (ref. NYM) from the actuator/switch to the motor must not exceed 100 m in case of motors with electronic end stops.

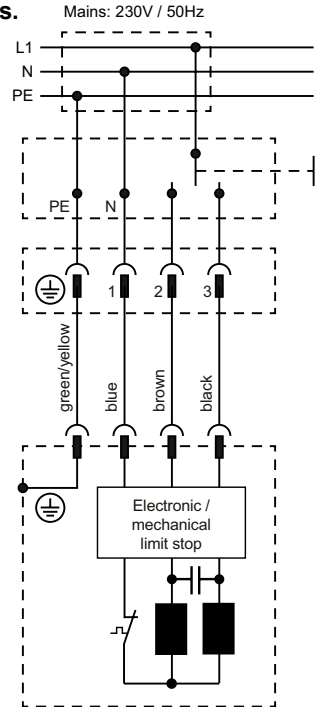

8. Connection of the setting switch



In order to set the end positions on SOLIDline motors, any setting switch can be used that has a programming key or that allows a simultaneous UP/DOWN command. In this case, the UP/DOWN keys must be activated simultaneously instead of the programming key.

EN

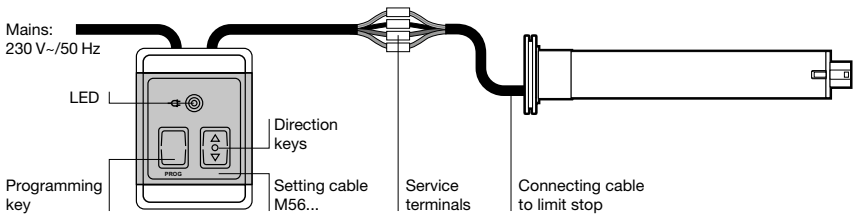

Connect setting cable to the connecting cable of the motor (see diagram on the back of the setting switch). The assignment to the direction of rotation is dependent on the installation situation of the drive. Then connect the setting switch to the 230V mains.

Article Number / Geiger setting switch

M56F152	with service terminal (D), 5 wires, SMI compatible
M56F153	with service terminal (CH), 5 wires, SMI compatible
M56F154	with service terminal (D), 4 wires

9. Control options

Characteristics of the controls Easy-ZIP and EasyWireless-ZIP			
	Easy-ZIP 1.x	Easy-ZIP 2.x	Easy-ZIP 3.x
Lower end position: free positioning or torque shutoff Upper end position: free positioning or torque shutoff	X	-	-
Qi mode: Move to lower end position and without stop retract screen. Upper end position: torque shutoff	-	X	-
Automatic mode: Lower and upper end position: torque shutoff	-	-	X
Dual-Stop-Control	X	X	X
Hanging length adjustment	X	X	X
Less charge in the upper end position	X	-	-
Geiger Powertronic (power level)	X	X	X
Geiger locking force reduction	X	X	X

10. Setting of the end positions with Easy-ZIP 1.x

Following installation types are possible:		Screen is equipped with:
A	Lower and upper end positions: with stop (torque shutoff)	Upper and lower stops
B	Lower end position: with stop Upper end position: freely adjustable	Lower stop Upper stop not necessary
C	Lower end position: freely adjustable Upper end position: with stop	Lower stop not necessary Upper stop
D	Lower and upper end positions: freely adjustable	Upper and lower stops not necessary

Change/delete the end positions

In order to change or delete the end positions, a new programming must be started (see «Setting of the end stops»).

EN

Programming the end positions

Variant A: lower and upper end positions with stop

To open the learning mode for end positions, press the PROG key or the UP and DOWN keys simultaneously until the motor confirms (1 x clac-clac). The motor jerks (start, stop, start) at each run command to confirm the learning mode activation.

Lower end position:

Press the UP or DOWN key until the sun protection system has reached the lower stop and the motor switches off automatically.

The lower end position is now stored.

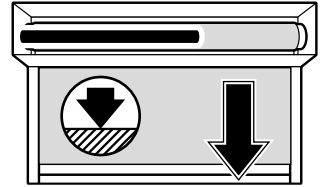

Upper end position:

Press the UP or DOWN key until the sun protection system has reached the upper stop and the motor switches off automatically.

The upper end position is now stored.

The programming is completed and the motor returns to normal mode.

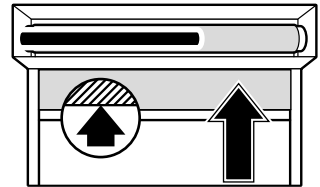

Variant B: lower end position with stop/upper end position freely adjustable

To open the learning mode for end positions, press the PROG key or the UP and DOWN keys simultaneously until the motor confirms (1 x clac-clac). The motor jerks (start, stop, start) at each run command to confirm the learning mode activation.

Lower end position:

Press the UP or DOWN key until the sun protection system has reached the lower stop and the motor switches off automatically.

The lower end position is now stored.

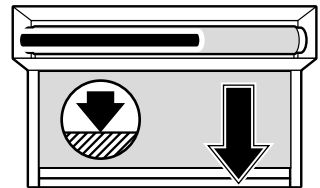

Upper end position:

Press the UP or DOWN key until the sun protection system has reached the selected upper end position. Corrections with the UP and DOWN keys are possible.

Press the programming key or the UP and DOWN keys at the same time until the motor confirms (3 x click-click).

The upper end position is now stored.

The programming is completed and the motor returns to normal mode.

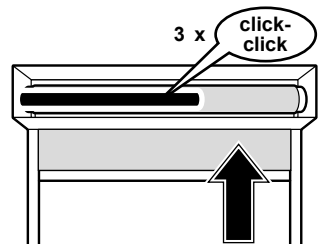

Variant C: lower end position freely adjustable/upper end position with stop

To open the learning mode for end positions, press the PROG key or the UP and DOWN keys simultaneously until the motor confirms (1 x clac-clac). The motor jerks (start, stop, start) at each run command to confirm the learning mode activation.

Lower end position:

Press the UP or DOWN key until the sun protection system has reached the selected lower end position. Corrections with the UP and DOWN keys are possible.

Press the programming key or the UP and DOWN keys at the same time until the motor confirms (2 x click-click).

The lower end position is now stored.

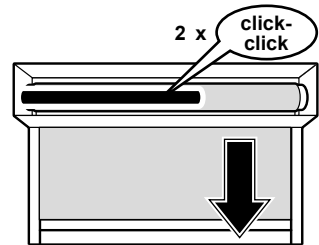

Upper end position:

Press the UP or DOWN key until the sun protection system has reached the upper stop and the motor switches off automatically.

The upper end position is now stored.

The programming is completed and the motor returns to normal mode.

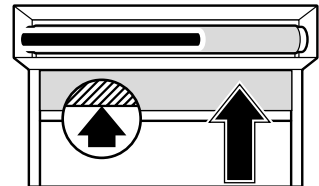

Variant D: lower and upper end positions freely adjustable

To open the learning mode for end positions, press the PROG key or the UP and DOWN keys simultaneously until the motor confirms (1 x clac-clac). The motor jerks (start, stop, start) at each run command to confirm the learning mode activation.

Lower end position:

Press the UP or DOWN key until the sun protection system has reached the selected lower end position. Corrections with the UP and DOWN keys are possible.

Press the programming key or the UP and DOWN keys at the same time until the motor confirms (2 x click-click).

The lower end position is now stored.

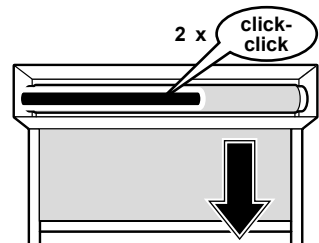

Upper end position:

Press the UP or DOWN key until the sun protection system has reached the selected upper end position. Corrections with the UP and DOWN keys are possible.

Press the programming key or the UP and DOWN keys at the same time until the motor confirms (3 x click-click).

The upper end position is now stored.

The programming is completed and the motor returns to normal mode.

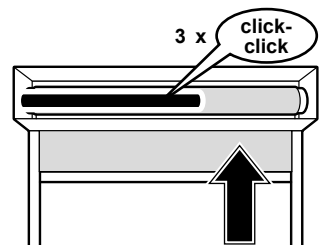

EN

Motor feedback

Easy-ZIP 1.x: variant A	
1 x click-click	• Learning mode for end positions activated
Easy-ZIP 1.x: variant B	
1 x click-click	• Learning mode for end positions activated
3 x click-click	• Storing of the upper end position is confirmed
Easy-ZIP 1.x: variant C	
1 x click-click	• Learning mode for end positions activated
2 x click-click	• Storing of the lower end position is confirmed
Easy-ZIP 1.x: variant D	
1 x click-click	• Learning mode for end positions activated
2 x click-click	• Storing of the lower end position is confirmed
3 x click-click	• Storing of the upper end position is confirmed

11. Setting of the end positions with Easy-ZIP 2.x (Qi mode)



The distance between the upper and lower end stops must be about 25 cm which corresponds to one tube rotation at least.

Programming the end positions

1. Connect the connecting cable of the motor to the control switch.
2. To open the learning mode for end positions, press the PROG key or the UP and DOWN keys simultaneously until the motor confirms (1 x clac-clac). The motor jerks (start, stop, start) at each run command to confirm the learning mode activation.
3. Move the screen to the required lower end position. Any adjustment can be realized here.
4. Move the screen to the upper position without any interruptions until the motor shuts down. (torque detection). The programming procedure is then completed and the motor returns to normal operating mode.

Motor feedback

Easy-ZIP 2.x

1 x click-click

• Learning mode for end positions activated

12. Setting of the end positions with Easy-ZIP 3.x (automatic mode)



The distance between the upper and lower end stops must be about 25 cm which corresponds to one tube rotation at least.

Programming the end positions

1. To open the learning mode for end positions, press the PROG key or the UP and DOWN keys simultaneously until the motor confirms (1 x clac-clac). The motor jerks (start, stop, start) at each run command to confirm the learning mode activation.
2. Keep UP or DOWN keys pressed to move the screen to the required lower end position until the motor automatically shuts down (torque shutoff).
3. Keep keys pressed
4. The screen moves now automatically to the upper end position. When the screen has reached the upper position the motor shuts off. The programming procedure is then completed and the motor returns to normal operating mode.

Motor feedback

Easy-ZIP 3.x

1 x click-click

• Learning mode for end positions activated

EN

13. Obstacle detection

When, after the teaching of the first complete, uninterrupted travel from one end position to the other end position is carried out, the torque needed is learnt.

In any following complete, uninterrupted travel from end position to end position, the torque needed is automatically readjusted. Slow changes in the installation due to ageing, soiling, cold or heat are thus automatically taken into consideration.

This process takes place for both running directions independently of one another. If a travel movement in UP or DOWN direction is blocked by an obstacle, the motor switches off.

The motor tries up to six times – depending on the configuration – to achieve the end position.

The running direction in which the obstacle was recognized is blocked. The block is removed if the motor has been operated in the opposite direction for a certain time. An obstacle must thus first be released before the motor can be operated again in the direction of the obstacle.



Because of the motor sensitive obstacle detection, the correct dimensioning of the torque for the respective installation size is essential.

Note: the chart below serves only as indication to determine the motor size.

Whether the specified motor size is sufficient for the respective installation size and is sensitive enough should be examined with the previously unknown factors like weight of the sun protection (total weight), friction, etc. for each installation type and size, as there might be important variations.

Total weight [kg]

Winding diameter [mm]	Total weight [kg]																				
	3	4	5	7,5	10	12,5	15	17,5	20	22,5	25	27,5	30	32,5	35	37,5	40	42,5	45	47,5	50
50	0,9	1,2	1,5	2,2	2,9	3,7	4,4	5,2	5,9	6,6	7,4	8,1	8,8	9,6	10,3	11,0	11,8	12,5	13,2	14,0	14,7
55	1,0	1,3	1,6	2,4	3,2	4,0	4,9	5,7	6,5	7,3	8,1	8,9	9,7	10,5	11,3	12,1	12,9	13,8	14,6	15,4	16,2
60	1,1	1,4	1,8	2,6	3,5	4,4	5,3	6,2	7,1	7,9	8,8	9,7	10,6	11,5	12,4	13,2	14,1	15,0	15,9	16,8	17,7
65	1,1	1,5	1,9	2,9	3,8	4,8	5,7	6,7	7,7	8,6	9,6	10,5	11,5	12,4	13,4	14,3	15,3	16,3	17,2	18,2	19,1
70	1,2	1,6	2,1	3,1	4,1	5,2	6,2	7,2	8,2	9,3	10,3	11,3	12,4	13,4	14,4	15,5	16,5	17,5	18,5	19,6	20,6
75	1,3	1,8	2,2	3,3	4,4	5,5	6,6	7,7	8,8	9,9	11,0	12,1	13,2	14,3	15,5	16,6	17,7	18,8	19,9	21,0	22,1
80	1,4	1,9	2,4	3,5	4,7	5,9	7,1	8,2	9,4	10,6	11,8	12,9	14,1	15,3	16,5	17,7	18,8	20,0	21,2	22,4	23,5
85	1,5	2,0	2,5	3,8	5,0	6,3	7,5	8,8	10,0	11,3	12,5	13,8	15,0	16,3	17,5	18,8	20,0	21,3	22,5	23,8	25,0
90	1,6	2,1	2,6	4,0	5,3	6,6	7,9	9,3	10,6	11,9	13,2	14,6	15,9	17,2	18,5	19,9	21,2	22,5	23,8	25,2	26,5
95	1,7	2,2	2,8	4,2	5,6	7,0	8,4	9,8	11,2	12,6	14,0	15,4	16,8	18,2	19,6	21,0	22,4	23,8	25,2	26,6	28,0
100	1,8	2,4	2,9	4,4	5,9	7,4	8,8	10,3	11,8	13,2	14,7	16,2	17,7	19,1	20,6	22,1	23,5	25,0	26,5	28,0	29,4
105	1,9	2,5	3,1	4,6	6,2	7,7	9,3	10,8	12,4	13,9	15,5	17,0	18,5	20,1	21,6	23,2	24,7	26,3	27,8	29,4	30,9
110	1,9	2,6	3,2	4,9	6,5	8,1	9,7	11,3	12,9	14,6	16,2	17,8	19,4	21,0	22,7	24,3	25,9	27,5	29,1	30,8	32,4
115	2,0	2,7	3,4	5,1	6,8	8,5	10,2	11,8	13,5	15,2	16,9	18,6	20,3	22,0	23,7	25,4	27,1	28,8	30,5	32,2	33,8
120	2,1	2,8	3,5	5,3	7,1	8,8	10,6	12,4	14,1	15,9	17,7	19,4	21,2	23,0	24,7	26,5	28,3	30,0	31,8	33,6	35,3
	3 Nm			6 Nm			9 Nm			12 Nm									SOLIDline ../55		
	6 Nm			10 Nm			20 Nm			30 Nm						SOLIDline					

Note: there is no matching motor size for the greyed out area.

These are estimated values so please check the correct functioning of the installation.



When using a wind sensor the correct functioning of the retract command under wind load should be checked by the manufacturer of the sun protection before commissioning.

14. Deactivating the obstacle detection in DOWN direction

With Easy-ZIP, the obstacle detection is deactivated with following sequence:

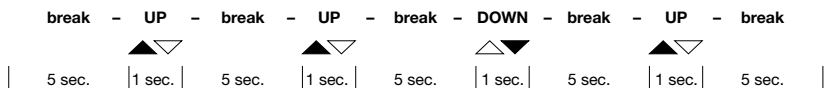

Then move the sun protection in DOWN direction otherwise the modification will not be accepted. The motor jerks 1 x for confirmation.

15. Reactivating the obstacle detection

The obstacle detection is active again as soon as the motor is switched into the learning mode for end positions.

16. End position correction

If a **lengthening/shortening** of the hanging has resulted due to e.g. temperature changes, this will be automatically corrected by closing the awning.

If, due to temperature changes, **modified winding behaviour** should arise and the hangings should run against the stop, an immediate end position correction takes place.

After the first reference run, the motor automatically identifies the torque necessary to close the screen and closes it with the lowest possible power, so that the fabric is optimally protected.

17. What to do if...

Problem	Solution
Motor does not run.	<ul style="list-style-type: none"> • Motor not plugged in. Please check the plug connection. • Check connecting cable for possible damage. • Check the mains voltage and allow the cause of the voltage breakdown to be tested by a specialist electrician.
Instead of in the upwards direction, motor runs downwards.	<ul style="list-style-type: none"> • The control leads are interchanged. Exchange black/brown control leads.
Motor only runs in one direction.	<ul style="list-style-type: none"> • Motor in the end position. Run motor in the opposite direction. Re-adjust the end positions, if necessary.
After running several times, the motor breaks down and no longer responds.	<ul style="list-style-type: none"> • The motor became too hot and has switched off. Try it again after a cooling time of about 15 min.

EN

18. Maintenance

The drive is maintenance-free.

19. Declaration of conformity



EU Declaration of Conformity

Gerhard Geiger GmbH & Co. KG
Antriebstechnik
Schleifmühle 6
D-74321 Bietigheim-Bissingen

Product designation:

Venetian blinds motor, motor for rolling shutters, motor for awnings

Type designation:

GR45..	GJ56..
G545..	GS56..
GU45..	GSI56..

Applied directives:

2006/42/EC
2014/30/EU
2014/53/EU
2011/65/EU

Applied standards:

DIN EN 60335-1 (VDE 0700-1):2012-10; EN 60335-1:2012
DIN EN 60335-1 Ber.1 (VDE 0700-1 Ber.1):2014-04; EN 60335-1:2012/AC:2014
EN 60335-1:2012/A11:2014
DIN EN 60335-2-97 (VDE 0700-97):2017-05; EN 60335-2-97:2006+A11:2008+A2:2010
+A12:2015
DIN EN 62233 (VDE 0700-366):2008-11; EN 62233:2008
DIN EN 62233 Ber.1 (VDE 0700-366 Ber.1):2009-04; EN 62233 Ber.1:2008
DIN EN ISO 12100:2011-03; EN ISO 12100:2010

DIN EN 55014-1:2012-05; EN 55014-1:2006 + A1:2009 + A2:2011
DIN EN 55014-2:2016-01; EN55014-2:2015
DIN EN 61000-3-2:2015-03; EN 61000-3-2:2014
DIN EN 61000-3-3:2014-03; EN 61000-3-3:2013
ETSI EN 301 489-1 V1.9.2(2011-09)
ETSI EN 301 489-3 V1.6.1(2013-08)
ETSI EN 300 220-2 V3.1.1(2017-02)

Authorized representative for technical data:

Gerhard Geiger GmbH & Co. KG

Address:

Schleifmühle 6, D-74321 Bietigheim-Bissingen

Bietigheim-Bissingen, 25.10.2018

Roland Kraus (General Manager)

100W1558 en 1018

Gerhard Geiger GmbH & Co. KG
Schleifmühle 6 | D-74321 Bietigheim-Bissingen
Phone +49 (0) 7142 9380 | Fax +49 (0) 7142 938 230 | info@geiger.de | www.geiger.de
Sitz Bietigheim-Bissingen | Amtsgericht Stuttgart HRA 300591 | USt-IdNr. DE145002146
Komplementär: Geiger Verwaltungs-GmbH | Sitz Bietigheim-Bissingen | Amtsgericht Stuttgart HRB 300481
Geschäftsführer: Roland Kraus | WEEE-Reg.-Nr. DE47902323

Current declarations of conformity are available under www.geiger.de

20. Technical data for SOLIDline motors with 16 revolutions per minute

Technical data of tubular motor SOLIDline-KS (GU45..)				
	GU4506	GU4510	GU4520	GU4530
Voltage	230V~/50Hz			
Current	0,36 A	0,47 A	0,63 A	0,8 A
Cos Phi (cosφ)	>0,95			
Inrush current (factor)	x 1,2			
Power	83 W	105 W	140 W	180 W
Torque	6 Nm	10 Nm	20 Nm	30 Nm
Speed	16 rpm	16 rpm	16 rpm	16 rpm
Protection class	IP 44			
Total length¹⁾	506,5 mm	516,5 mm	546,5 mm	566,5 mm
Operating mode	S2 4 min	S2 4 min	S2 5 min	S2 4 min
Sound pressure level²⁾	39 dB(A)	39 dB(A)	41 dB(A)	41 dB(A)
Diameter	45 mm			
Weight	approx. 1,85 kg	approx. 1,90 kg	approx. 2,20 kg	approx. 2,40 kg
Storage temperature/ Humidity	T = -15°C .. +70°C / dry and non-condensing place			

¹⁾ SOLIDline-ROC + 8,9 mm / SOLIDline-COM + 3,5 mm / SOLIDline-SOC: + 3 mm / SOLIDline-SIL: \pm 0 mm (without trunnion)

²⁾ The average sound pressure level data are intended for guidance only. The values were determined by Geiger at a distance of 1 m, with a hanging motor at idle speed and averaged over 10 seconds. There is no reference to any specific test standard.

Subject to technical modifications. Please find information to the ambient temperature range of our Geiger motors under www.geiger.de



21. Technical data for SOLIDline motors with 55 revolutions per minute

Technical data of tubular motor SOLIDline-KS (GU45..)				
	GU4503/55	GU4506/55	GU4509/55	GU4512/55
Voltage	230V~/50Hz	230V~/50Hz	230V~/50Hz	230V~/50Hz
Current	0,47 A	0,63 A	0,8 A	1,0 A
Cos Phi (cosφ)	>0,95	>0,95	>0,95	>0,95
Inrush current (factor)	x 1,2	x 1,2	x 1,2	x 1,2
Power	105 W	140 W	180 W	220 W
Torque	3 Nm	6 Nm	9 Nm	12 Nm
Speed	55 rpm	55 rpm	55 rpm	55 rpm
Protection class	IP 44	IP 44	IP 44	IP 44
Total length¹⁾	515,5 mm	545,5 mm	565,5 mm	585,5 mm
Operating mode	S2 4 min	S2 5 min	S2 4 min	S2 4 min
Diameter	45 mm	45 mm	45 mm	45 mm
Weight	approx. 1,9 kg	approx. 2,2 kg	approx. 2,4 kg	approx. 2,7 kg
Storage temperature/ Humidity	T = -15°C .. +70°C / dry and non-condensing place			

¹⁾ SOLIDline-ROC + 8,9 mm / SOLIDline-COM + 3,5 mm / SOLIDline-SOC: + 3 mm / SOLIDline-SIL: \pm 0 mm (without trunnion)

Subject to technical modifications.

Please find information to the ambient temperature range of our Geiger motors under www.geiger.de



EN

22. Notes on waste disposal

Recycling of packaging materials

In the interest of environmental protection, please contact your local government's recycling or solid waste management department to learn more about the services it provides.

Waste disposal of electric and electronic equipment

Electrical and electronic equipment must be collected and disposed of separately in accordance with EU regulations.

EN

For technical questions, please call our service team at: **+49 (0) 7142 938 333**.
They will be happy to assist you.

GEIGER
PARTNER TO THE SUN

Gerhard Geiger GmbH & Co. KG
Schleifmühle 6 | D-74321 Bietigheim-Bissingen
T +49 (0) 7142 9380 | F +49 (0) 7142 938 230
info@geiger.de | www.geiger.de

