

Tubular motor:

**GEIGER PRO.TECline**

Motor control:

**PRO.TECline Spindle (GB45...-M01)**

for rolling shutters and screens



EN

**Original assembly and  
operating instructions**

EN

# Index

1. General information .....	2
2. Guarantee .....	3
3. Intended use .....	3
4. Safety instructions .....	3
5. Safety instructions for assembly .....	4
6. Installation instructions .....	5
7. Information for the specialist electrician .....	6
8. Setting of the end positions .....	6
9. What to do if .....	8
10. Technical data .....	9
11. Maintenance .....	9
12. Notes on waste disposal .....	9
13. Declaration of conformity .....	10

EN

## 1. General information

Dear customer,

By purchasing a GEIGER motor you have decided on a quality product from GEIGER.

Thank you very much for your decision and the confidence placed in us.

Before you put this drive into operation please observe the following safety instructions. It serves for the prevention of danger and for the avoidance of personal injury and damage to property.

The installation and operating instructions contain important information for the installer, the specialist electrician and the user. Please pass on these instructions if you transfer the product. These instructions should be kept by the user.

## 2. Guarantee

In the case of incorrect installation contrary to the installation and operating instructions and/or constructional modification, the legal and contractual guarantee for property damage and product liability lapses.

## 3. Intended use

The tubular motors of the model range **PRO.TEcline (GB45...-M01)** with the **Spindle** system are designed exclusively for the operation of rolling shutters and screens.

The motors may not be used for the operation of roller grilles, garage doors, furniture and lifting tools.

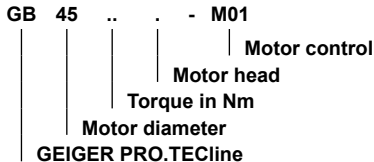

## 4. Safety instructions



**ATTENTION: Important safety instructions. For personal safety, it is important to follow these instructions. Please keep these instructions for future reference.**

- ▶ Do not allow children to play with stationary controls. Keep remote controls away from children.
- ▶ The installation is to be checked regularly for defective balance, signs of wear or damaged cables and springs, if relevant.
- ▶ Do observe the moving sun protection system and keep persons away until it has closed completely.
- ▶ When operating the manual release with the sun protection system open, please be cautious as it can fall down quickly if springs or tapes wear off or are broken.
- ▶ Do not operate the device if operations such as, for example, window cleaning are to be carried out in the vicinity.
- ▶ Disconnect the automatic controlled device from the mains power supply if operations such as, for example, window cleaning are being carried out in the vicinity.
- ▶ During operation observe the danger zone.
- ▶ Do not use the installation if people or objects are in the danger zone.
- ▶ Urgently shut down damaged installations until repair.
- ▶ Unconditionally shut down the unit during maintenance and cleaning operations.
- ▶ Pinching and shearing points are to be avoided and must be secured.
- ▶ This appliance can be used by children aged 8 and above and persons whose physical, sensorial or mental capacities are impaired, or who have no experience or know-how if they have been supervised or been given instructions on the use of the appliance and if they understand the possible resulting dangers. Children are not permitted to play with the device. Cleaning and maintenance should not be carried out by children.
- ▶ The rated sound pressure level is less than 70 dB(A).
- ▶ Disconnect the device from the mains power supply for maintenance and replacement of parts.  
If the motor is disconnected via a plug connection the operator must be able to control - from any place to which it has access – that the plug is removed.  
If this is not possible - due to design or installation - the disconnection from the power supply must be ensured via locking in the disconnected position (e.g. isolator).
- ▶ The motor tube can get very hot during prolonged use.  
When working on the unit, do not touch the tube before it has cooled down.

## 5. Safety instructions for assembly



**ATTENTION: Important safety instructions. Follow all installation instructions, as incorrect installation can lead to serious injuries.**

- ▶ When mounting the motor without any mechanical protection of the driven parts and of the tube which may become hot, the motor must be installed at a height of at least 2.5 m above the ground or of another level which provides access to the drive.
- ▶ Before the motor is installed, all cables which are not needed are to be removed and all equipment which is not needed for power-operated actuation is to be put out of operation.
- ▶ The actuating element of a manual release must be mounted at a height of less than 1.8 m.
- ▶ If the motor is controlled by a switch or pushbutton, the switch or pushbutton must be mounted within eyeshot of the motor. The switch or pushbutton must not be located in the vicinity of moving parts. The height of installation must be at least 1.5 m above the floor.
- ▶ Permanently installed control devices must be attached visibly.
- ▶ In case of devices extending horizontally, a horizontal distance of at least 0.4 m must be respected between the fully extended part and any other fixed element.
- ▶ The rated speed and the rated torque of the motor must be compatible with the device.
- ▶ The mounting accessories that are used must be designed in accordance with the selected rated torque.
- ▶ Good technical knowledge and good mechanical skills are necessary for the motor installation. Incorrect installation can lead to serious injury. Electrical work must be carried out by a qualified electrician in accordance with the regulations in force locally.
- ▶ Only use connecting cables that are suitable with the environmental conditions and which meet the construction requirements. (see accessories catalogue)
- ▶ If the device is not equipped with a connecting cable and a plug, or other means for disconnecting from the mains with a contact opening on each pole according to the conditions of the overvoltage category III for full disconnection, a disconnecting device of this type must be incorporated into the permanently installed electrical installation according to the wiring rules.
- ▶ Do not mount the connecting cables near hot surfaces.
- ▶ A plug for the disconnection of the motor from the power supply must be accessible after installation.
- ▶ Damaged connecting cables must be replaced by GEIGER connecting cables of the same type.
- ▶ The device must be mounted as described in the installation instructions. Fixations shall not be made with adhesives since they are regarded as unreliable.

EN

## 6. Installation instructions



Prior to installation please check to ensure there is no visible damage to the motor like cracks or open cables.



Before fixing please check the strength of the masonry and of the surface.



**Caution:** If the tube is screwed/riveted to the drive, the measure must be taken from the tube end to the center of the drive and marked on the tube.

When drilling the winding shaft never drill into the area of the tubular motor!

When inserting into the shaft, the tubular motor must not be struck and must not be allowed to fall into the shaft.

### Installation into the rolling shutter:

Fix motor support to available stud bolts or in the side frame.

Insert motor into the shaft with a suitable adapter and drive up to the stop of the shaft adapter.

Insert roller capsule on the opposite side.

Put shaft with motor on motor support or on pivoting engine bearer. On the opposite side pull out roller capsule until bolt fits into ball bearing.

Screw together roller capsule with shaft.

Screw together shaft with tubular carrier.

Fix rolling shutter casing to shaft.

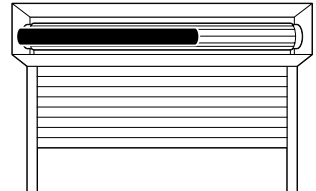
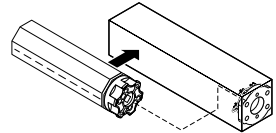
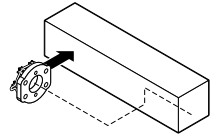

### Installation into screens:

Insert motor with a suitable adapter and drive into the shaft up to the stop of the shaft adapter.

Fix the motor support on the awning. Fix the motor together with the shaft on the motor support. The bearer locks into place.

**Depending on the selected motor head, different fixation systems can be used:**

- Place the motor with square insert in the star-shaped bearer and lock with pin
- Place the motor into the existing engine bearer and lock
- Place the motor in a compatible engine bearer with clip system and lock with spring or rotating lever



**The GEIGER PRO.TEcline motor is suitable for shaft diameters from 50 mm!**

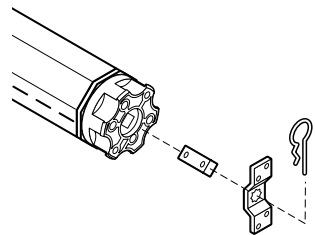

EN

## 7. Information for the specialist electrician



**Caution: Important installation instructions.**  
Please follow all instructions since incorrect installation can lead to the destruction of the motor and the switching unit.

Because of back-voltage of the capacitor, the parallel connection of the PRO.TECline Spindle is not permissible. Please do not use any installation switch which allows simultaneous up and down controls.

The operations with the service clamps may be accomplished only by an electrical specialist.

When changing the running direction the switchover must be effected through an off-position.

When changing the running direction the switchover time must be at least 0.5 s.

PVC cables are not suitable for equipment used outdoors or exposed to prolonged high levels of UV radiation. These cables should not be used if they are likely to touch metal parts that can heat up to temperatures exceeding 70°C.

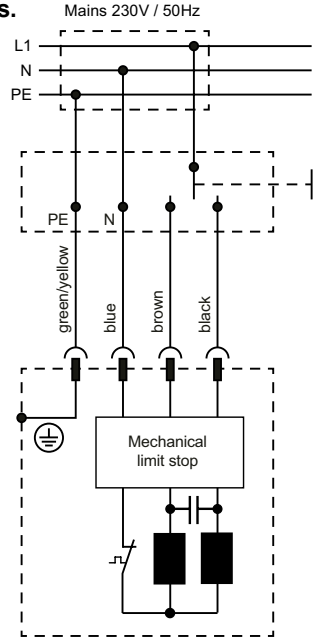

## 8. Setting of the end positions



**CAUTION: In the factory setting, the motor can make 2 rotations in both directions.**

### Installation configuration

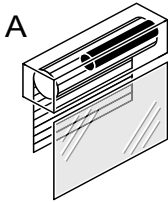

Top-mounted box/  
right-hand installation

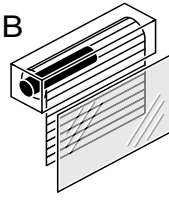

Front-mounted box/  
left-hand installation

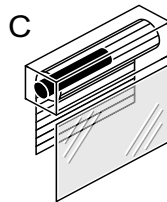

Top-mounted box/  
left-hand installation

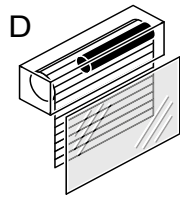

Front-mounted box/  
right-hand installation

The setting of the end positions for installation situations A and B is described below.

In situations C and D, the assignment of the setting screws changes.

To turn the setting screws, use a 4mm hexagon key or the included adjustment aid.

## Changing the setting range

Irrespective of the assignment of the setting screws:

- Rotation in **minus** direction **reduces** the setting range
- Rotation in **plus** direction **increases** the setting range

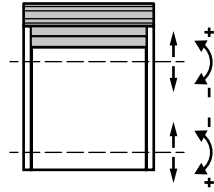

## Setting the upper end position

Press the UP key on the control switch until the hanging stops automatically.

Depending on the installation situation, turn the corresponding setting screw with UP key pressed down in PLUS direction until the selected upper end position is reached.

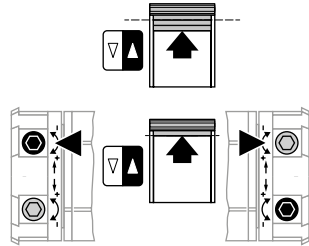

### If the upper end position is overrun (the motor switches off too late):

- Press the DOWN key until the hanging is below the selected end position.
- Turn the setting screw a few turns in MINUS direction and repeat the procedure described above again.

## Setting the lower end position

Press the DOWN key on the control switch until the hanging stops automatically.

Depending on the installation situation, turn the corresponding setting screw with DOWN key pressed down in PLUS direction until the selected lower end position is reached.

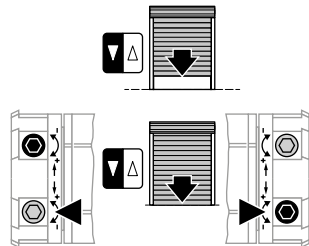

### If the lower end position is overrun (the motor switches off too late):

- Press the UP key until the hanging is above the selected end position.
- Turn the setting screw a few turns in MINUS direction and repeat the procedure described above again.

## 9. What to do if...

Problem	Solution
<b>Motor does not run.</b>	<ul style="list-style-type: none"> <li>• Motor not plugged in. Please check the plug connection.</li> <li>• Check connecting cable for possible damage.</li> <li>• Check the mains voltage and allow the cause of the voltage breakdown to be tested by a specialist electrician.</li> </ul>
<b>Instead of in the upwards direction, motor runs downwards.</b>	<ul style="list-style-type: none"> <li>• The control leads are interchanged. Exchange black/brown control leads.</li> </ul>
<b>Motor only runs in one direction.</b>	<ul style="list-style-type: none"> <li>• Motor in the end position. Run motor in the opposite direction.</li> <li>• Check control leads.</li> </ul>
<b>After running several times, the motor breaks down and no longer responds.</b>	<ul style="list-style-type: none"> <li>• The motor became too hot and has switched off. Try it again after a cooling time of about 15 min.</li> </ul>
<b>The adjusted end position is not correct.</b>	<ul style="list-style-type: none"> <li>• Adjusting knob not pressed properly. Repeat adjustment process, press adjusting knob deeply.</li> <li>• Actuator does not rotate simultaneously. Push shaft onto tube actuator, repeat adjustment process.</li> </ul>



## 10. Technical data

Technical data of tubular motor PRO.TEcline Spindle (GB45..)		
	GB4510	GB4520
Voltage	230 V~/50 Hz	
Current	0,47 A	0,63 A
Cos Phi (cosφ)	>0,95	
Inrush current (factor)	x 1,2	
Power	105 W	140 W
Torque	10 Nm	20 Nm
Speed	15 rpm	
Protection class	IP 44	
Total length	438 mm	468 mm
Operating mode	S2 4 min	
Sound pressure level <sup>1)</sup>	39 dB(A)	
Diameter	45 mm	
Limit switch range	22 rotations	
Weight	approx 1,90 kg	approx 2,00 kg
Storage temperature/ Humidity	T = -15°C .. +70°C / dry and non-condensing place	

<sup>1)</sup> The average sound pressure level data are intended for guidance only. The values were determined by GEIGER at a distance of 1 m, with a hanging motor at idle speed and averaged over 10 seconds. There is no reference to any specific test standard.

Subject to technical modifications. Please find information to the ambient temperature range of our GEIGER motors under [www.geiger.de](http://www.geiger.de)



## 11. Maintenance

The drive is maintenance-free.

## 12. Notes on waste disposal

### Recycling of packaging materials

In the interest of environmental protection, please contact your local government's recycling or solid waste management department to learn more about the services it provides.

### Waste disposal of electric and electronic equipment

Electrical and electronic equipment must be collected and disposed of separately in accordance with EU regulations.

EN

# 13. Declaration of conformity



## EU Declaration of Conformity

Gerhard Geiger GmbH & Co. KG  
Antriebstechnik  
Schleifmühle 6  
D-74321 Bietigheim-Bissingen

### Product designation:

Venetian blinds motor, motor for rolling shutters, motor for awnings

### Type designation:

GR45..	GJ56..
GS45..	GS56..
GU45..	GS156..
GB45..	

### Applied directives:

2006/42/EC  
2014/30/EU  
2014/53/EU  
2011/65/EU + (EU)2015/863 + (EU)2017/2102

### Applied standards:

DIN EN 60335-1 (VDE 0700-1):2012-10; EN 60335-1:2012  
DIN EN 60335-1 Ber.1 (VDE 0700-1 Ber.1):2014-04; EN 60335-1:2012/AC:2014  
EN 60335-1:2012/A11:2014  
DIN EN 60335-2-97 (VDE 0700-97):2017-05; EN 60335-2-97:2006+A11:2008+A2:2010  
+A12:2015  
DIN EN 62233 (VDE 0700-366):2008-11; EN 62233:2008  
DIN EN 62233 Ber.1 (VDE 0700-366 Ber.1):2009-04; EN 62233 Ber.1:2008  
DIN EN ISO 12100:2011-03; EN ISO 12100:2010  
  
DIN EN 55014-1:2012-05; EN 55014-1:2006 + A1:2009 + A2:2011  
DIN EN 55014-2:2016-01; EN55014-2:2015  
DIN EN 61000-3-2:2015-03; EN 61000-3-2:2014  
DIN EN 61000-3-3:2014-03; EN 61000-3-3:2013  
ETSI EN 301 489-1 V1.9.2(2011-09)  
ETSI EN 301 489-3 V1.6.1(2013-08)  
ETSI EN 300 220-2 V3.1.1(2017-02)

### Authorized representative for technical data:

Gerhard Geiger GmbH & Co. KG

### Address:

Schleifmühle 6, D-74321 Bietigheim-Bissingen

Bietigheim-Bissingen, 25.06.2019

Roland Kraus (General Manager)

100W1518 en 0819

Gerhard Geiger GmbH & Co. KG  
Schleifmühle 6 | D-74321 Bietigheim-Bissingen  
Phone +49 (0) 7142 9380 | Fax +49 (0) 7142 938 230 | info@geiger.de | www.geiger.de  
Sitz Bietigheim-Bissingen | Amtsgericht Stuttgart HRA 300591 | USt-IdNr. DE145002146  
Komplementär: Geiger Verwaltungs-GmbH | Sitz Bietigheim-Bissingen | Amtsgericht Stuttgart HRB 300481  
Geschäftsführer: Roland Kraus | WEEE-Reg.-Nr. DE47902323

Current declarations of conformity are available under [www.geiger.de](http://www.geiger.de)

**EN**

For technical questions, please call our service team at: **+49 (0) 7142 938 333**.  
They will be happy to assist you.

**GEIGER**  
ANTRIEBSTECHNIK

**Gerhard Geiger GmbH & Co. KG**  
Schleifmühle 6 | D-74321 Bietigheim-Bissingen  
T +49 (0) 7142 9380 | F +49 (0) 7142 938 230  
info@geiger.de | www.geiger.de

