

GEIGER

PARTNER TO THE SUN

Tubular motor:

GEIGER-MODULARline

Motor control:

GEIGER-SoftPerfection-S (GR45..E04)

for rolling shutters with stoppers and anti-lift device

EN Operating Instructions

EN

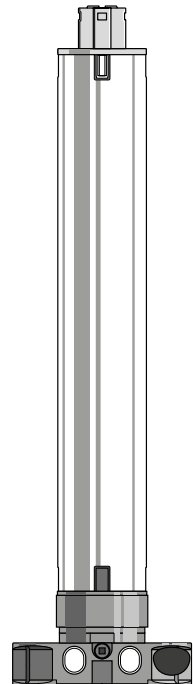

Index

1. GEIGER-SoftPerfection-S: Special features	3
2. General information	4
3. Guarantee.....	4
4. Safety information	4
5. Intended use	5
6. Installation instructions	6
7. Setting of end stops	7
8. Delete the end positions	7
9. Obstacle recognition.....	7
10. End position correction	7
11. Technical data.....	8
12. Declaration of conformity.....	8
13. Information for the specialist electrician	9
14. Notes on waste disposal	9
15. What to do if... ..	10

EN

1. GEIGER-SoftPerfection-S: Special features

Application range: rolling shutter systems

Precondition: anti-lift device and stoppers

Initial operation with Plug & Play

- Only one operation to the upper and the lower end stop is required.
Ready! Plug & Play!

Cloth protection with the Soft-System

- The GEIGER Soft position ensures that the hanging stops a few millimetres before reaching the upper end position. The hanging is thus optimally protected. Two exceptions: the programming runs and the reference runs after 50 cycles.
- During the programming of the reference runs the GEIGER motor control ensures a “soft shutdown” when reaching the upper end positions. Hanging and the rolling shutter system – compared to conventional torque motors – are well preserved.

Synchronous position in the upper end position

- The **GEIGER-SoftPerfection-S** ensures that the bottom lath in the upper end position is always the same distance away from the upper end rail.
- When rolling shutters of different sizes are mounted next to each other, the bottom laths are positioned on the same level. This is a really nice visual upgrade for the house façade: **the GEIGER-synchronous position.**

EN

Obstacle detection

- Protection of the rolling shutter system during retraction

Antifreeze protection

- The situation «hanging frozen to the window sill», is recognized by the system and the curtain will not be damaged.

Safety

- A torque shutoff is effected after each cycle in the lower end position. This makes it fairly difficult to lift up the curtain.

2. General information

Dear customer,

By purchasing a GEIGER tubular motor you have decided on a quality product from GEIGER.

Thank you very much for your decision and the confidence placed in us.

Before you put this drive into operation please observe the following safety information. It serves for the prevention of danger and for the avoidance of personal injury and damage to property.

Please retain this information for future reference.

- ▶ **Suitable for all types of rolling shutters with anti-lift device and stoppers**
- ▶ **Drives are switchable in parallel**

3. Guarantee

In the case of incorrect installation contrary to the operating instructions and/or constructional modification, the legal and contractual guarantee for property damage and product liability lapses.

4. Safety information



ATTENTION: Important safety information. For personal safety, it is important to follow these instructions. The instructions should be kept.

- ▶ **This appliance is not to be used by persons (including children) whose physical, sensorial or mental capacities are impaired, or who have no experience or know-how, unless they have been supervised or been given instructions on the use of the appliance by someone who is responsible for their safety.**
- ▶ **Children must be supervised to make sure they do not play with the appliance.**
- ▶ **The installation is to be checked regularly for defective balance, wear and damage.**
- ▶ **Damaged connecting leads must be replaced by the GEIGER connecting lead of the same wire type.**
- ▶ **During operation observe the danger zone.**
- ▶ **If people or objects are in the danger zone, do not use the installation.**
- ▶ **Urgently shut down damaged installations until repair.**
- ▶ **Unconditionally shut down the unit during maintenance and cleaning operations.**
- ▶ **Pinching and shearing sites are to be avoided and to be safeguarded against.**
- ▶ **When operating the manual actuator with the open sun protection system, exercise caution as it can fall down quickly if springs expand or are broken.**
- ▶ **Do not operate the device if operations such as, for example, window cleaning are to be carried out in the vicinity.**

- ▶ **Disconnect the device from the mains power supply if operations such as, for example, window cleaning are being carried out in the vicinity.**



ATTENTION: Important safety information. Follow all installation instructions, as incorrect installation can lead to serious injuries.

- ▶ **Connection must be carried out by a skilled electrician according to the regulations in force locally.**
- ▶ **The mains plug of the tubular motor must be accessible after installation.**
- ▶ **On the installation of the tubular motor without mechanical protection of the driven parts, the tubular motor must be installed at a height of at least 2.5 m above the ground or of another level which provides access to the drive.**
- ▶ **Before the tubular motor is installed, all leads which are not needed are to be removed and all equipment which is not needed for actuation is to be put out of operation.**
- ▶ **If the tubular motor is controlled by a switch or pushbutton, the switch or pushbutton must be mounted within eyeshot of the tubular motor. The switch or pushbutton must not be located in the vicinity of moving parts. The height of installation must be at least 1.5 m above the floor.**
If the apparatus is equipped without a pin and a socket connector (STAS3K) in the connecting lead, or other means for disconnecting from the mains with at least a 3 mm contact opening on each pole, a disconnecting device of this type must be incorporated into the permanently installed electrical installation according to the wiring rules.
- ▶ **Permanently installed control devices must be attached visibly.**
- ▶ **The correct dimensioning of the drive is to be observed.**

5. Intended use

The tubular motors of the model range **MODULARline (GR45..E04)** with the **SoftPerfection-S** system are designed exclusively for the operation of rolling shutters with anti-lift device and stoppers

If the tubular motors are used for other applications and/or modifications are performed to the tubular motors, which have not been discussed with GEIGER Antriebstechnik, then the manufacturer is **not** liable for personal injury and/or damage to property and for consequential damage.

6. Installation instructions

Before fixing, the strength of the masonry or of the subsurface is to be checked.



Caution: If the tube is screwed/riveted to the drive, the measure must be taken from the tube end to the center of the drive and marked on the tube.

When drilling the winding shaft **never** drill into the area of the tubular motor!

When inserting into the shaft, the tubular motor must **not** be struck and must **not** be allowed to fall into the shaft.

GEIGER connector system:

Connection of limit stop and short motor:

1. Snap suitable tubular adapter onto the short motor.
2. In the case of an electronic limit stop **MODULAR-line SoftPerfection-S*** (GR45..E03), the magnetic shaft M45B033 must additionally be inserted into the short motor (see figure).

Disconnection of limit stop and short motor:

1. The drive **must** first be disconnected from the mains.
2. Twist the unlocking lever with a 5 mm hexagon socket key.
3. The short motor can then be removed simply from the limit stop.

Installation into the rolling shutter:

Fix motor support to available stud bolts or in the side frame.

Insert motor into the shaft with a suitable adapter and drive up to the stop of the shaft adapter.

Insert roller capsule on the opposite side.

Clip shaft with motor to motor support.

On the opposite side pull out roller capsule until bolt fits into ball bearing.

Screw together roller capsule with shaft.

Screw together shaft with tubular carrier.

Fix roller shutter casing to shaft.

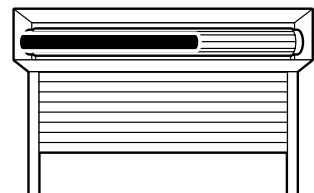
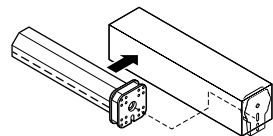
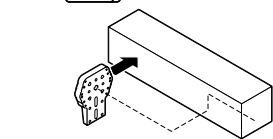
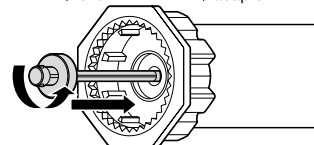
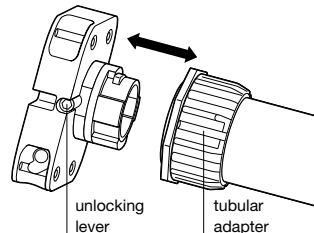
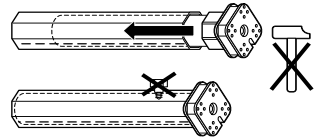

In order to adjust the end positions, a rolling shutter system with upper end stop and anti-lift device is required.

* The magnetic shaft M45B033 must be installed into the motor with all electronic and radio controlled limit stops such as GEIGER-Easy (GR45..E01), GEIGER-SoftZero (GR45..E02), GEIGER-SoftPerfection (GR45..E03), GEIGER-SoftPerfection-S (GR45..E04) and GEIGER-VariousWireless (GR45..F01).

7. Setting of end stops

1. Connect the connecting cable to the motor
2. Move the shutter to both end positions once (any order will do)
3. **DONE!**

8. Delete the end positions

1. Move the curtain to any position of your choice.



Please note: respect a distance of approximately 50 cm from the end positions

2. Operate as follows:

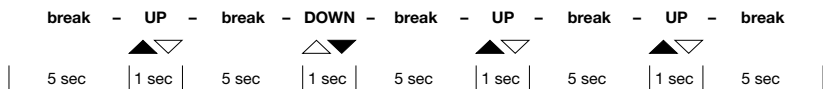

Please note: a break of at least 5 seconds must be respected between the different runs.

3. **DONE!**

9. Obstacle recognition

When, after the teaching of the first complete, uninterrupted travel from one end position to the other end position is carried out, the torque needed is learnt.

In any following complete, uninterrupted travel from end position to end position, the torque needed is automatically reset. Slow changes in the installation due to ageing, soiling, cold or heat are thus automatically taken into consideration.

If a travel movement in UP direction is blocked by an obstacle, the motor switches off and a small return motion takes place.

The running direction in which the obstacle was recognized is blocked.

The block is removed if the motor has been operated in the opposite direction for a certain time. An obstacle must thus first be released before the motor can be operated again in the direction of the obstacle.

EN

10. End position correction



The engine needs to be taught with the end stops (stopper and anti-lift device).

Checking of the end position, and if appropriate an end position correction, takes place after 5, 20, and then every 50 cycles.

Should a hangings elongation have resulted, due to temperature changes, this is corrected at the next end position correction.

If, due to temperature changes, modified winding behaviour should arise and the hangings should run against the stop, an immediate end position correction takes place. In addition, the counter for the end position correction is started afresh.

11. Technical data

Technical data of short motor MODULARline (GR45..)		
	GR4510	GR4520
Voltage	230 V~/50 Hz	230 V~/50 Hz
Current	0,47 A	0,63 A
Cos Phi (cosφ)	>0,95	>0,95
Inrush current (factor)	x 1,2	x 1,2
Power	105 W	140 W
Torque	10 Nm	20 Nm
Speed of rotation	16 1/min	16 1/min
Protection type	IP 44	IP 44
Total length	400 mm	430 mm
Operating type	S2 4 min	S2 5 min
Diameter	45 mm	45 mm
Weight	approx. 1,5 kg	approx. 1,7 kg

Subject to technical modifications



12. Declaration of conformity

We herewith explicitly declare that this product complies with the essential requirements and relevant directives. It is authorised for use in all EC member states and in Switzerland without any need of prior registration. The Declaration of Conformity concerning this product is available on our website:

www.geiger-antriebstechnik.de.

EN

13. Information for the specialist electrician



Caution: Wrong installation and wrong connection can lead to serious injuries.

The parallel operation of the several **MODULAR-line SoftPerfection-S** is possible. Please observe the rating of the control switch used.

Please do not use any installation switch which allows simultaneous up and down controls.

PVC cables are not suitable for equipment used outdoors or exposed to prolonged high levels of UV radiation.

These cables should not be used if they are likely to touch metal parts that can heat up to temperatures exceeding 100°C.

Connecting cables with plug connectors of the Hirschmann Company, type STAS 3K or the Phoenix Mecano Company, type GLS/3+PE may only be used in connection with the Hirschmann cable socket STAK 3K.

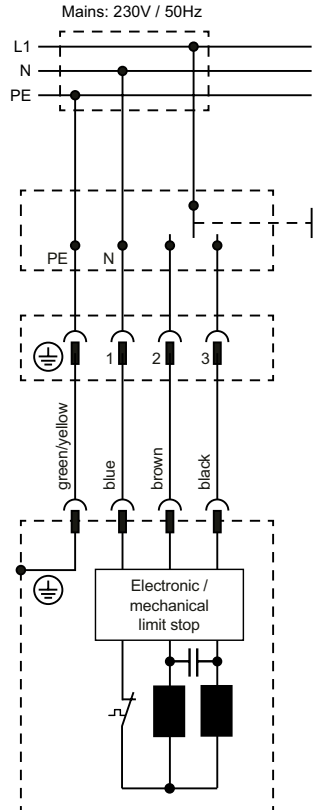

14. Notes on waste disposal

Recycling of packaging materials

In the interest of environmental protection, please contact your local government's recycling or solid waste management department to learn more about the services it provides.

Waste disposal of electric and electronic equipment

Electronic equipment or batteries cannot be discarded along with the normal household waste. Keep for more information on the recycling and disposal methods envisaged by the local regulations in your area.

EN

15. What to do if...

Problem	Solution
Motor does not run.	<ul style="list-style-type: none"> • Motor not plugged in. Please check the plug connection. • Check connecting cable for possible damage. • Check the mains voltage and allow the cause of the voltage breakdown to be tested by a specialist electrician.
Instead of in the upwards direction, motor runs downwards.	<ul style="list-style-type: none"> • The control leads are interchanged. Exchange black/brown control leads.
Motor only runs in one direction.	<ul style="list-style-type: none"> • Motor in the end position. Run motor in the opposite direction.
After running several times, the motor breaks down and no longer responds.	<ul style="list-style-type: none"> • The motor became too hot and has switched off. Try it again after a cooling time of about 15 min.
The motor stops half way.	<ul style="list-style-type: none"> • Magnetic counter M45B033 not mounted. Remove the end stop system and place the magnetic counter into the motor.
Setting is not possible.	<ul style="list-style-type: none"> • Magnetic counter M45B033 not mounted. Remove the end stop system and place the magnetic counter into the motor.

EN

For technical questions, please call our service team at: **+49 (0) 7142 938-333**. They will be happy to assist you.

GEIGER

PARTNER TO THE SUN

Gerhard Geiger GmbH & Co. KG

Schleifmühle 6

D-74321 Bietigheim-Bissingen

Telephone: +49 (0) 7142 938-0

Telefax: +49 (0) 7142 938-230

E-Mail: info@geiger.de

Internet: www.geiger.de

