

Tubular motor:

## **GEIGER-MODULARline**

Motor control:

## **GEIGER-Touch (GR45..M)**

for rolling shutters and screens

**EN**

**Operating Instructions**

**EN**

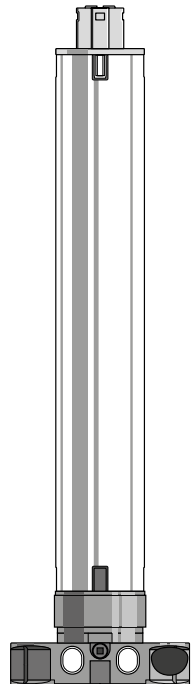

# Index

<b>1. General information .....</b>	<b>3</b>
<b>2. Guarantee.....</b>	<b>3</b>
<b>3. Safety information .....</b>	<b>3</b>
<b>4. Intended use .....</b>	<b>4</b>
<b>5. Installation instructions .....</b>	<b>5</b>
<b>6. Setting of the end stops.....</b>	<b>6</b>
<b>7. Obstacle detection .....</b>	<b>7</b>
<b>8. Technical data.....</b>	<b>8</b>
<b>9. Declaration of conformity .....</b>	<b>8</b>
<b>10. Information for the specialist electrician .....</b>	<b>9</b>
<b>11. Notes on waste disposal .....</b>	<b>9</b>
<b>12. What to do if... ..</b>	<b>10</b>

**EN**

# 1. General information

Dear customer,

By purchasing a GEIGER tubular motor you have decided on a quality product from GEIGER.

Thank you very much for your decision and the confidence placed in us.

Before you put this drive into operation please observe the following safety information. It serves for the prevention of danger and for the avoidance of personal injury and damage to property.

**Please retain this information for future reference.**

- ▶ **Suitable for all rolling shutter systems and screens**
- ▶ **Installation without stops possible**

# 2. Guarantee

In the case of incorrect installation contrary to the operating instructions and/or constructional modification, the legal and contractual guarantee for property damage and product liability lapses.

# 3. Safety information



**ATTENTION: Important safety information. For personal safety, it is important to follow these instructions. The instructions should be kept.**

- ▶ **This appliance is not to be used by persons (including children) whose physical, sensorial or mental capacities are impaired, or who have no experience or know-how, unless they have been supervised or been given instructions on the use of the appliance by someone who is responsible for their safety.**
- ▶ **Children must be supervised to make sure they do not play with the appliance.**
- ▶ **The installation is to be checked regularly for defective balance, wear and damage.**
- ▶ **Damaged connecting leads must be replaced by the GEIGER connecting lead of the same wire type.**
- ▶ **During operation observe the danger zone.**
- ▶ **If people or objects are in the danger zone, do not use the installation.**
- ▶ **Urgently shut down damaged installations until repair.**
- ▶ **Unconditionally shut down the unit during maintenance and cleaning operations.**
- ▶ **Pinching and shearing sites are to be avoided and to be safeguarded against.**
- ▶ **When operating the manual actuator with the open sun protection system, exercise caution as it can fall down quickly if springs expand or are broken.**
- ▶ **Do not operate the device if operations such as, for example, window cleaning are to be carried out in the vicinity.**

EN

- ▶ **Disconnect the device from the mains power supply if operations such as, for example, window cleaning are being carried out in the vicinity.**



**ATTENTION: Important safety information. Follow all installation instructions, as incorrect installation can lead to serious injuries.**

- ▶ **Connection must be carried out by a skilled electrician according to the regulations in force locally.**
- ▶ **The mains plug of the tubular motor must be accessible after installation.**
- ▶ **On the installation of the tubular motor without mechanical protection of the driven parts, the tubular motor must be installed at a height of at least 2.5 m above the ground or of another level which provides access to the drive.**
- ▶ **Before the tubular motor is installed, all leads which are not needed are to be removed and all equipment which is not needed for actuation is to be put out of operation.**
- ▶ **If the tubular motor is controlled by a switch or pushbutton, the switch or pushbutton must be mounted within eyeshot of the tubular motor. The switch or pushbutton must not be located in the vicinity of moving parts. The height of installation must be at least 1.5 m above the floor.**  
**If the apparatus is equipped without a pin and a socket connector (STAS3K) in the connecting lead, or other means for disconnecting from the mains with at least a 3 mm contact opening on each pole, a disconnecting device of this type must be incorporated into the permanently installed electrical installation according to the wiring rules.**
- ▶ **Permanently installed control devices must be attached visibly.**
- ▶ **The correct dimensioning of the drive is to be observed.**

## 4. Intended use

The tubular motors of the model range **MODULARline (GR45..M)** with the **Touch** system are designed exclusively for the operation of rolling shutters and screens.

If the tubular motors are used for other applications and/or modifications are performed to the tubular motors, which have not been discussed with **GEIGER Antriebstechnik**, then the manufacturer is not liable for personal injury and/or damage to property and for consequential damage.

## 5. Installation instructions

Before fixing, the strength of the masonry or of the subsurface is to be checked.



**ATTENTION:** Before the tubular motor is installed in the shaft, the measurement from the roller end up to the centre of the carrier is to be measured and marked on the roller.

When drilling the winding shaft **never** drill into the area of the tubular motor!

When inserting into the shaft, the tubular motor must **not** be struck and must **not** be allowed to fall into the shaft.

### GEIGER connector system:

#### Connection of limit stop and short motor:

1. Snap suitable tubular adapter onto the short motor.

#### Disconnection of limit stop and short motor:

1. The drive **must** first be disconnected from the mains.
2. Twist the unlocking lever with a 5 mm hexagon socket key.
3. The short motor can then be removed simply from the limit stop.

#### Installation into the rolling shutter:

Fix motor support to available stud bolts or in the side frame.

Insert motor into the shaft with a suitable adapter and drive up to the stop of the shaft adapter.

Insert roller capsule on the opposite side.

Clip shaft with motor to motor support.

On the opposite side pull out roller capsule until bolt fits into ball bearing.

Screw together roller capsule with shaft.

Screw together shaft with tubular carrier.

Fix roller shutter casing to shaft.

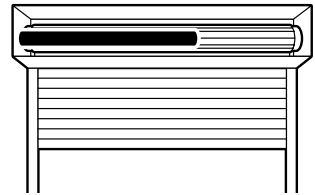
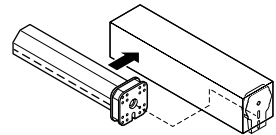
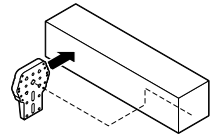
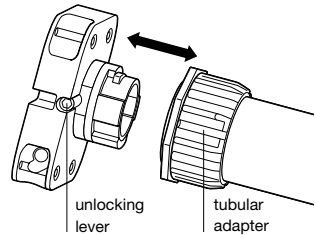
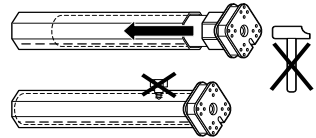

EN

## 6. Setting of the end stops



**NOTE:** You can begin with the upper or lower end position.



**ATTENTION:** Make sure that the setting button is pushed to dead stop, otherwise the motor could keep operating.

### Setting of the end positions:

1. Move the rolling shutter at least 300 mm **below** the required end position
2. Press **both** setting buttons
3. Move up the rolling shutter to the required end position (One of the two buttons jumps back during operation)
4. Once the required position is reached, move down the rolling shutter about 3 seconds until the second setting button jumps back audibly (click). The upper end stop is thus adjusted
5. Stop the rolling shutter and press again **both** setting buttons
6. Move down the rolling shutter to the required end position (One of the two buttons jumps back during operation)
7. Once the required position is reached, move up the rolling shutter about seconds until the second setting button jumps back audibly (click). The lower end stop is thus adjusted.

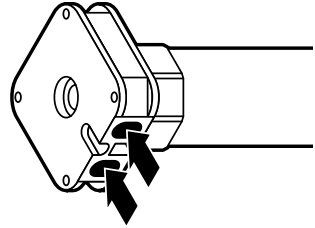

**NOTE:** If you want to readjust the end position, please move a little bit the rolling shutter in the opposite direction before repeating the operation.



There is no need to first delete the end stops (memorised) if you wish to modify them.

## 7. Technical data

EN

Technical data of short motor MODULARline (GR45..)		
	GR4510	GR4520
<b>Voltage</b>	230V~/50Hz	230V~/50Hz
<b>Current</b>	0,47 A	0,63 A
<b>Cos Phi (cosφ)</b>	>0,95	>0,95
<b>Inrush current (factor)</b>	x 1,2	x 1,2
<b>Power</b>	105 W	140 W
<b>Torque</b>	10 Nm	20 Nm
<b>Speed of rotation</b>	16 1/min	16 1/min
<b>Protection type</b>	IP 44	IP 44
<b>Total length<sup>1)</sup></b>	400 mm	430 mm
<b>Operating type</b>	S2 4 min	S2 5 min
<b>Diameter</b>	45 mm	45 mm
<b>Weight</b>	approx. 1,5 kg	approx. 1,7 kg

Subject to technical modifications



## 8. Declaration of conformity

We herewith explicitly declare that this product complies with the essential requirements and relevant directives. It is authorised for use in all EC member states and in Switzerland without any need of prior registration. The Declaration of Conformity concerning this product is available on our website: [www.geiger-antriebstechnik.de](http://www.geiger-antriebstechnik.de).

## 9. Information for the specialist electrician



**Caution: Wrong installation and wrong connection can lead to serious injuries.**

Because of back-voltage of the capacitor, the parallel connection of the **MODULARline Touch** is not permissible.

Please do not use any installation switch which allows simultaneous up and down controls.

PVC cables are not suitable for equipment used outdoors or exposed to prolonged high levels of UV radiation.

These cables should not be used if they are likely to touch metal parts that can heat up to temperatures exceeding 100°C.

Connecting cables with plug connectors of the Hirschmann Company, type STAS 3K or the Phoenix Mecano Company, type GLS/3+PE may only be used in connection with the Hirschmann cable socket STAK 3K.

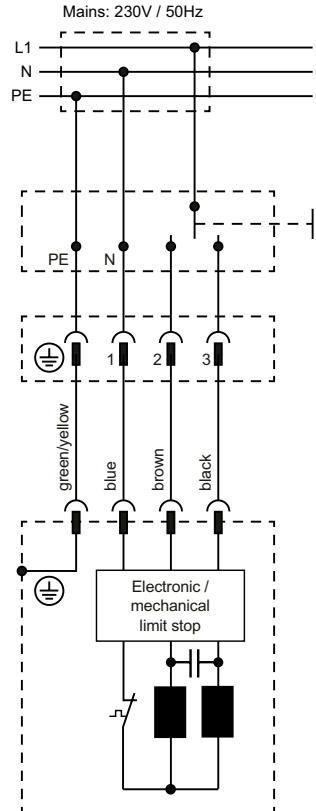

EN

## 10. Notes on waste disposal

### Recycling of packaging materials

In the interest of environmental protection, please contact your local government's recycling or solid waste management department to learn more about the services it provides.

### Waste disposal of electric and electronic equipment

Electronic equipment or batteries cannot be discarded along with the normal household waste. Keep for more information on the recycling and disposal methods envisaged by the local regulations in your area.

## 11. What to do if...

Problem	Solution
<b>Motor does not run.</b>	<ul style="list-style-type: none"> <li>• Motor not plugged in. Please check the plug connection.</li> <li>• Check connecting cable for possible damage.</li> <li>• Check the mains voltage and allow the cause of the voltage breakdown to be tested by a specialist electrician.</li> </ul>
<b>Instead of in the upwards direction, motor runs downwards.</b>	<ul style="list-style-type: none"> <li>• The control leads are interchanged. Exchange black/brown control leads.</li> </ul>
<b>Motor only runs in one direction.</b>	<ul style="list-style-type: none"> <li>• Motor in the end position. Run motor in the opposite direction.</li> </ul>
<b>After running several times, the motor breaks down and no longer responds.</b>	<ul style="list-style-type: none"> <li>• The motor became too hot and has switched off. Try it again after a cooling time of about 15 min.</li> </ul>
<b>The adjusted end position is not correct.</b>	<ul style="list-style-type: none"> <li>• Adjusting knob not pressed properly. Repeat adjustment process, press adjusting knob deeply.</li> <li>• Actuator does not rotate simultaneously. Push shaft onto tube actuator, repeat adjustment process.</li> </ul>

EN

For technical questions, please call our service team at: **+49 (0) 7142 938-333**. They will be happy to assist you.



**Gerhard Geiger GmbH & Co. KG**  
 Schleifmühle 6  
 D-74321 Bietigheim-Bissingen  
 Telephone: +49 (0) 7142 938-0  
 Telefax: +49 (0) 7142 938-230  
 E-Mail: [info@geiger.de](mailto:info@geiger.de)  
 Internet: [www.geiger.de](http://www.geiger.de)

